

# Team Room

March 2022



## Sports Complex

160-B

FACILITIES MANAGEMENT AND DEVELOPMENT

Space Data [http://afd.calpoly.edu/facilities/spacefacility/space\\_data.asp](http://afd.calpoly.edu/facilities/spacefacility/space_data.asp)



1:10

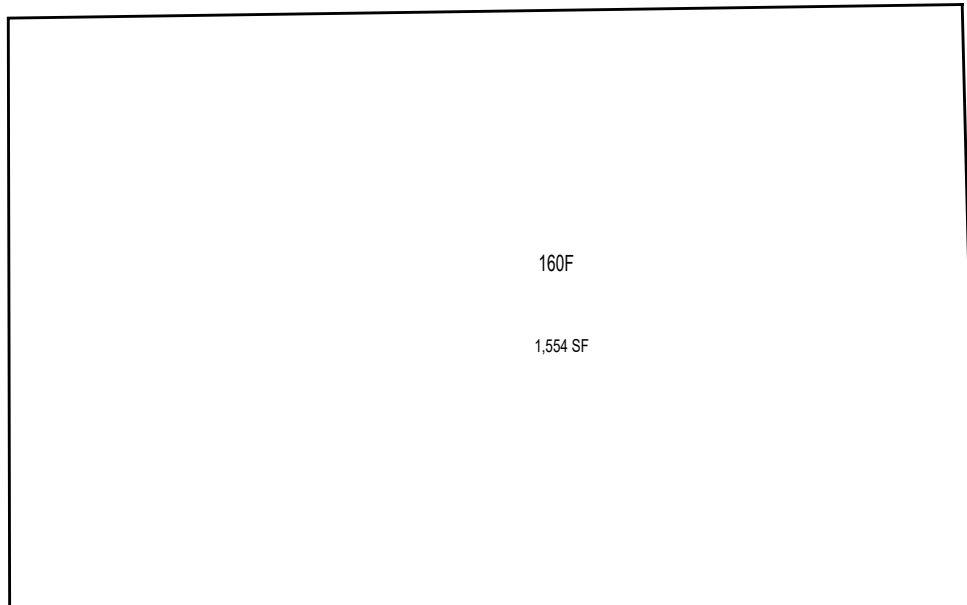

## Maintenance Building (160-F)

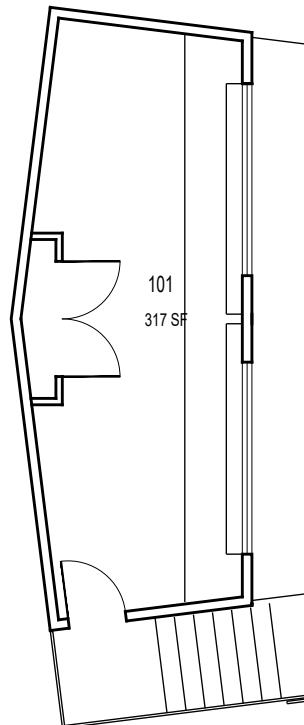

## Press Box (160-C)

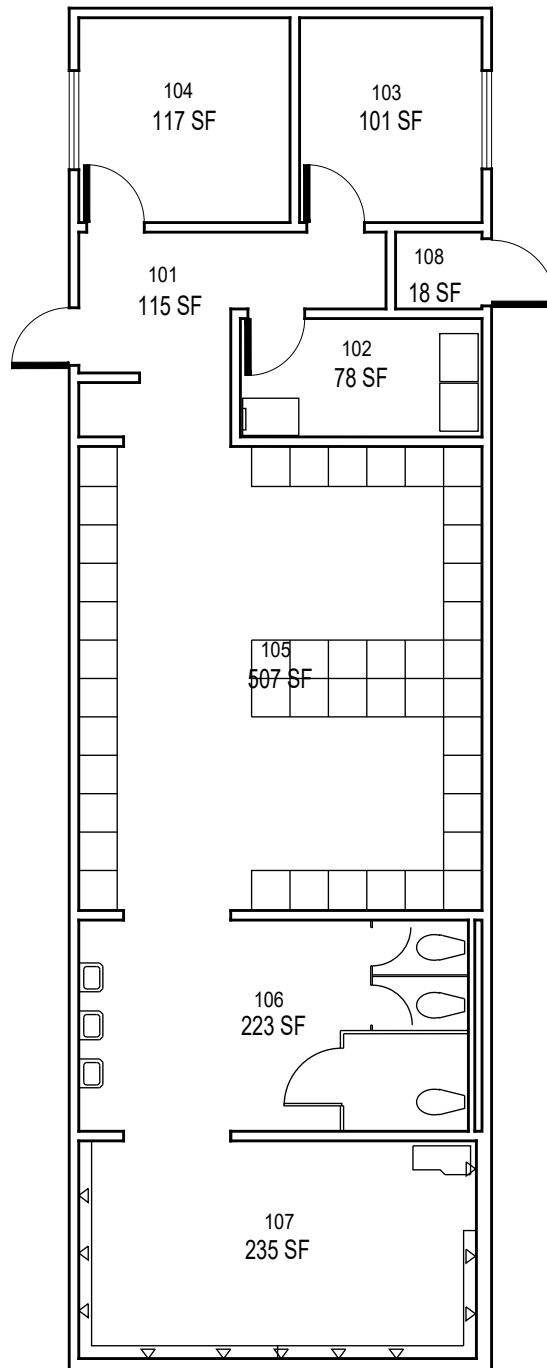

# Softball Lockers

March 2022



Sports Complex

161-A

FACILITIES MANAGEMENT AND DEVELOPMENT

Space Data [http://afd.calpoly.edu/facilities/spacefacility/space\\_data.asp](http://afd.calpoly.edu/facilities/spacefacility/space_data.asp)



1:10

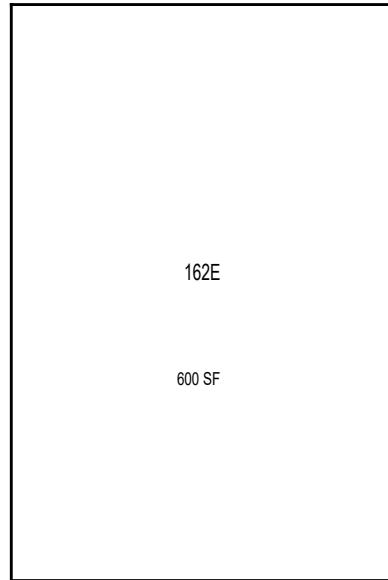

## 162-E Upper Fields Maintenance Shed

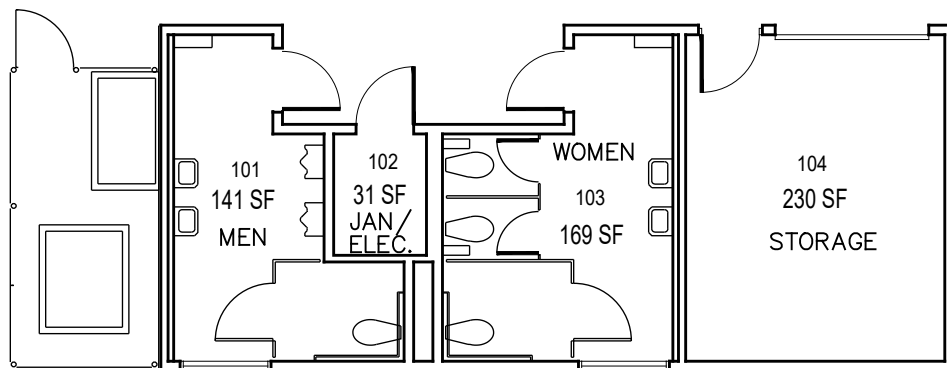

## 162-D Restroom 1

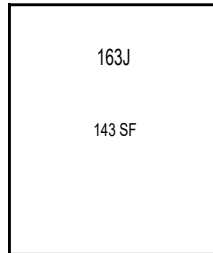

## 163-J South Scorekeepers Station

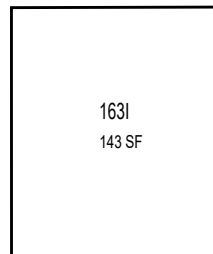

## 163-I Mid Scorekeepers Station

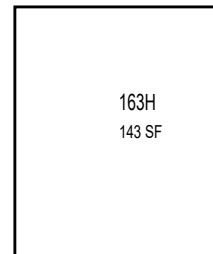

## 163-H North Scorekeepers Station